

Part Number: PT278-42131

Kit Contents

Item #	Quantity Reqd.	Description
1	1	Roof Rack Rail, LH
2	1	Roof Rack Rail, RH
3	1	Hardware Bag #1
4	1	Hardware Bag #2

Hardware Bag #1 Contents

Item #	Quantity Reqd.	Description
1	8	Screw, M8x1.25x49

Hardware Bag #2 Contents

Item #	Quantity Reqd.	Description
1	1	Cover, Front LH
2	1	Cover, Front RH
3	1	Cover, Rear LH
4	1	Cover, Rear RH

Additional Items Required For Installation

Item #	Quantity Reqd.	Description
1	1	Crossbar Kit PT278-42130

Conflicts

OE Side Rail

Recommended Tools

Personal & Vehicle Protection	Notes
Safety Goggles	
Vehicle Protection	
Wrist & Belt Buckle Protectors	
Special Tools	Notes
Installation Tools	Notes
Torque Wrench	0-50 lbf-ft
10mm Socket	
12 mm Socket	
Ratchet	
3" Extension	
Nylon Panel Removal Tool	i.e.: Panel Pry Tool #1 Toyota SST#00002-06001-01
Special Chemicals	Notes
Cleaner	Approved Cleaner

General Applicability

--

Recommended Sequence of Application

Item #	Accessory

*Mandatory

Vehicle Service Parts (may be required for reassembly)

Item #	Quantity Reqd.	Description
1		
2		
3		

Legend

 **STOP:** Damage to the vehicle may occur. Do not proceed until process has been complied with.

 **OPERATOR SAFETY:** Use caution to avoid risk of injury.

 **CAUTION:** A process that must be carefully observed in order to reduce the risk of damage to the accessory/vehicle and to ensure a quality installation.

 **TOOLS & EQUIPMENT:** Used in Figures calls out the specific tools and equipment recommended for this process.

 **REVISION MARK:** This mark highlights a change in installation with respect to previous issue.

 **SAFETY TORQUE:** This mark indicates that torque is related to safety.



Care must be taken when installing this accessory to ensure damage does not occur to the vehicle. The installation of this accessory should follow approved guidelines to ensure a quality installation.

These guidelines can be found in the "Accessory Installation Practices" document.

This document covers such items as:-

- Vehicle Protection (use of covers and blankets, cleaning chemicals, etc.).
- Safety (eye protection, rechecking torque procedure, etc.).
- Vehicle Disassembly/Reassembly (panel removal, part storage, etc.).
- Electrical Component Disassembly/Reassembly (battery disconnection, connector removal, etc.).

Please see your Toyota dealer for a copy of this document.

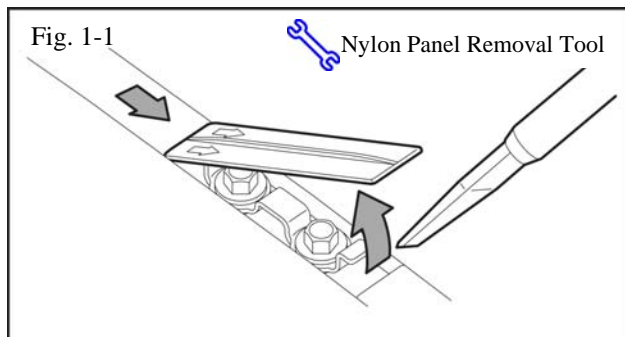

**1. Remove Ditch Molding Access Covers.
(4 locations)**

(a) Push on end with the arrows in the direction of the arrows.

 (b) Lift up on the opposite end while pushing the arrow end. (Fig. 1-1) Use Nylon Panel Removal Tool as needed to pry cover up.

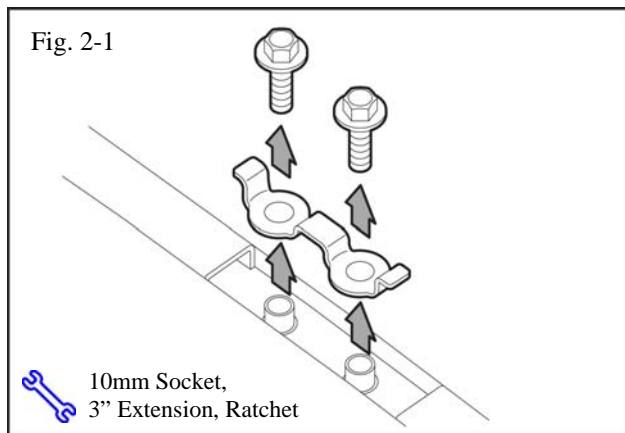

2. Remove Bolts and Bracket.

(a) Remove 8 Bolts and discard. (4 each side)
(Fig. 2-1)

(b) Remove Bracket and discard. (2 each side)
(Fig. 2-1)

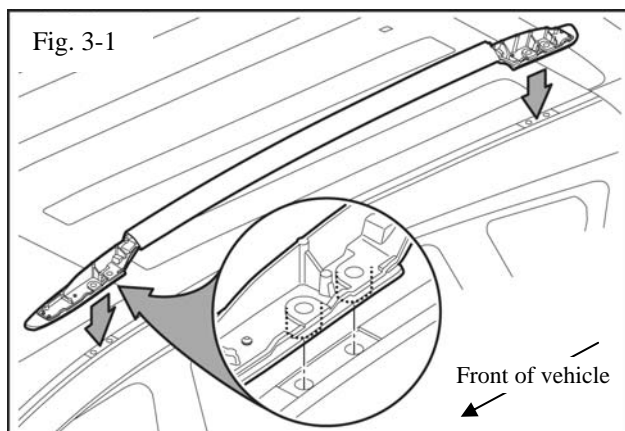



3. Install Roof Rack Side Rail

(a) Position LH side rail on to roof as shown
(Fig. 3-1)

(1) Identify LH side rail by markings on legs.

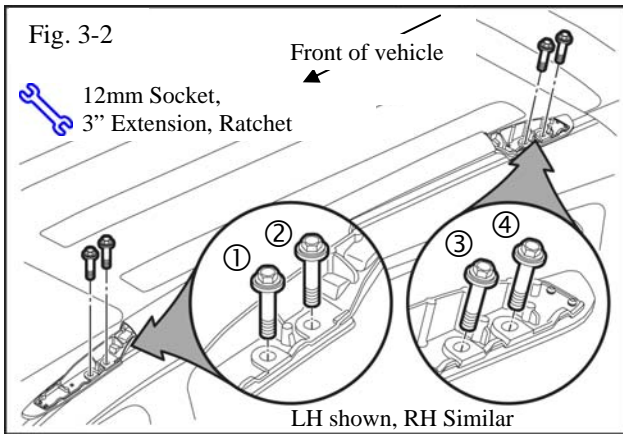
 (b) Carefully align holes in side rail legs with holes in roof ditch.



 (c) Install the LH roof rack rail leg bolts in sequential order ①, ②, ③, and ④ using the M8x1.25x49 bolts. (4 required) (Fig. 3-2)

(d) Torque bolts to 23 N·m (17 ft·lbf)

 **Torque: 23 N·m (17 ft·lbf)**

 (e) Repeat (a)-(d) for the RH roof rack rail.

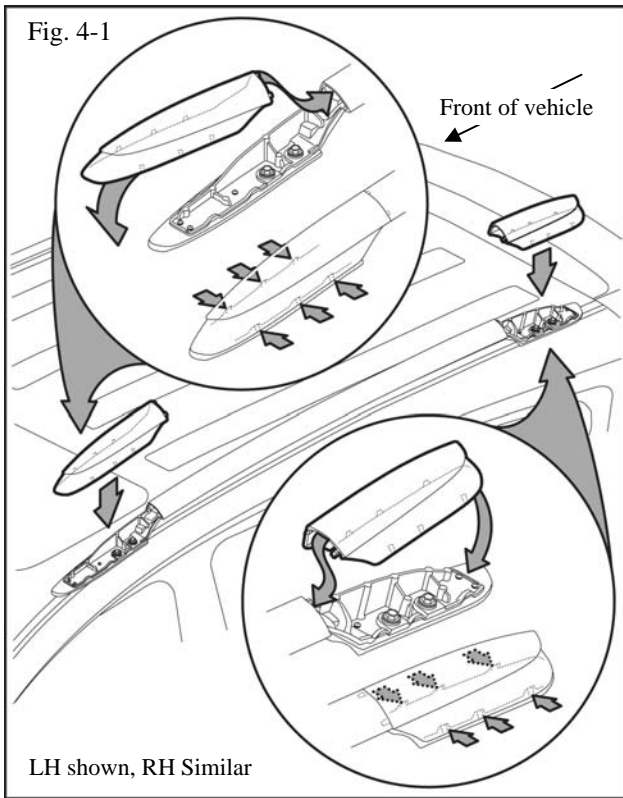

4. Install Roof Rack Side Rail Leg Covers.

 (a) Carefully position locking tabs into side rail (Fig. 4-1).

 (b) Press down on cover until 3 outer and 3 inner clips engage the leg (Fig. 4-1).

 (c) Confirm that all 4 covers are installed securely (Fig. 4-2).

5. Install Crossbars

(a) Refer to 2013 RAV4 CROSSBAR KIT installation instructions, PT278-42130.

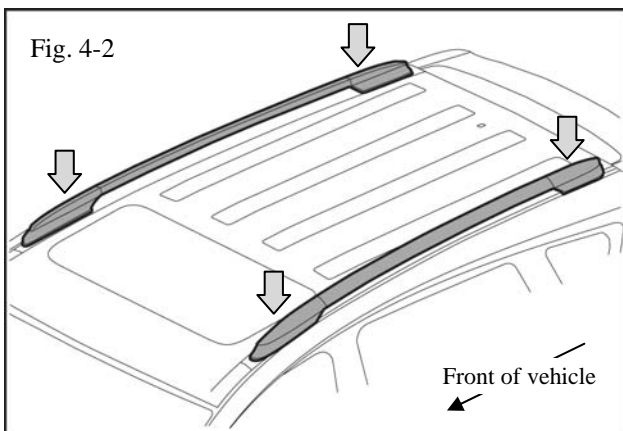

TOYOTA RAV4 2013- ROOF RACK SIDE RAILS
 Checklist - these points **MUST** be checked to ensure a quality installation.

<u>Check:</u>	<u>Look For:</u>
<p><u>Accessory Function Checks</u></p> <p><input type="checkbox"/> Side rail covers</p> <p><input type="checkbox"/> Side Rail Pads</p> <p><input type="checkbox"/> Gap between roof rack side rail pads and vehicle roof surface.</p>	<p>Ensure side rail covers are attached firmly with no gaps.</p> <p>Ensure side rail pads are flat to the roof surface (not rolled under).</p> <p>Not greater than 1.5 mm</p>
<p><u>Vehicle Function Checks</u></p> <p><input type="checkbox"/> None Required</p>	
<p><u>Vehicle Appearance Check</u></p> <p><input type="checkbox"/> After accessory installation and removal of protective cover(s), perform a visual inspection.</p>	<p>Ensure no damage (including scuffs and scratches) was caused during the installation process.</p> <p>(For PPO installations, refer to TMS Accessory Quality Shipping Standard.)</p>